



No. 12 "U" TYPE RECEPTACLE - RANGE .161 TO .213

DATE	DRAWN	CHKD	SCALE	DRAWING NUMBER
3-9-60	D.S.T.	MRT	2 : 1	J-12-11029-11

CONCORDVILLE, PA

REV.	DATE	BY-CHKD	REVISIONS	PART No.	MATERIAL	FINISH			
L	2-8-82	JGK	PRN: S-1-01	12-11029-11	1064 STEEL	DACROTIZED™			
M	9-28-89	TAB	PRN: 12-143						
N	12APR93	ALC	PRN: S-1-03						

PANEL PREPARATION

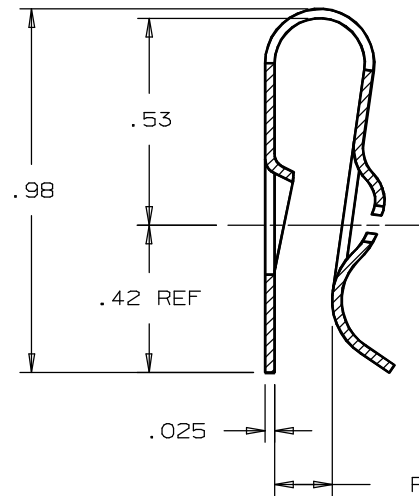

PANEL THICKNESS  
RANGE .161 TO .213

