

RECOMMENDED
INSTALLATION
TOOLING

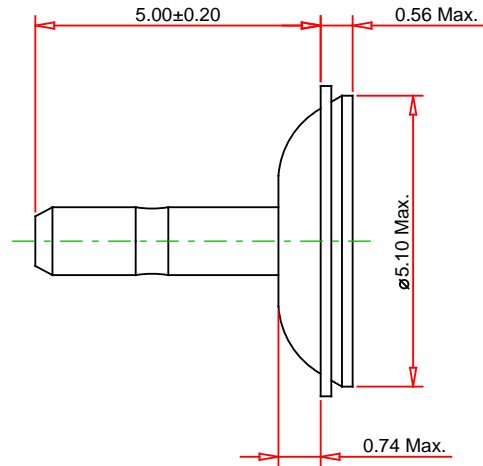
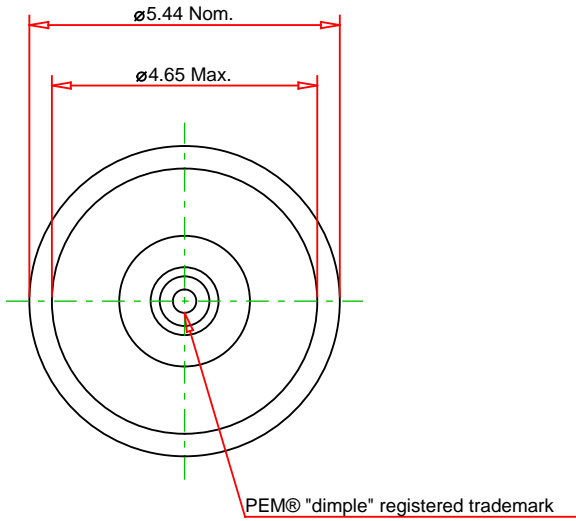
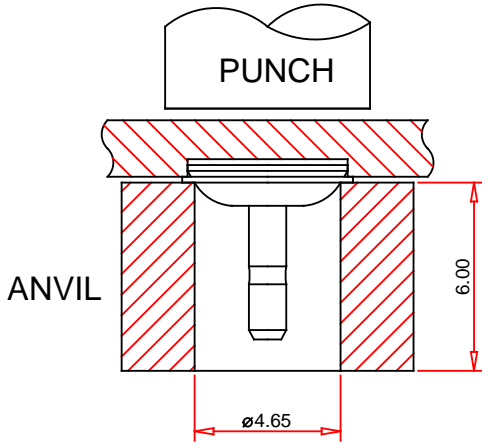

© 2024 PennEngineering

ALL DIMENSIONS IN MILLIMETERS

DATE 10-APR-2024

NOTE : DRAWING NOT TO SCALE

THREAD :	NONE	MOUNTING HOLE DIA. :	5.11 +0.08
MATERIAL:	STAINLESS STEEL	PANEL THICKNESS:	1.8 MIN
HEAT TREAT:	NONE	MAX. PANEL HARDNESS:	HRB 70 / HB 125
FINISH:	NONE	MIN CENTERLINE-TO-EDGE:	3.6

DESCRIPTION :
MRHPS™ Floating Pins



PennEngineering®

PART NO. :
MRHPS-1.2MM-500

EMAIL: TECHSUPPORT@PEMNET.COM
WWW.PEMNET.COM