

COMPONENT	MATERIAL	HEAT TREAT	FINISH
BEARING	300 SERIES STAINLESS STEEL	NONE	PASSIVATED AND/OR TESTED PER ASTM A380
RETAINER	THROUGH HARDENED CARBON STEEL	NONE	SEMI-BRIGHT ELECTROLESS NICKEL PER ASTM B733

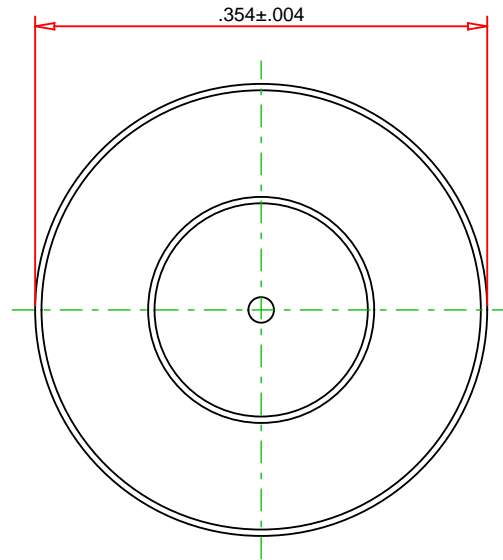

**RECOMMENDED
INSTALLATION
TOOLING**

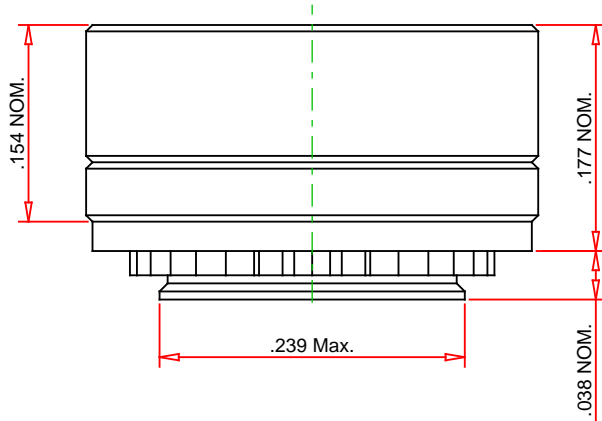
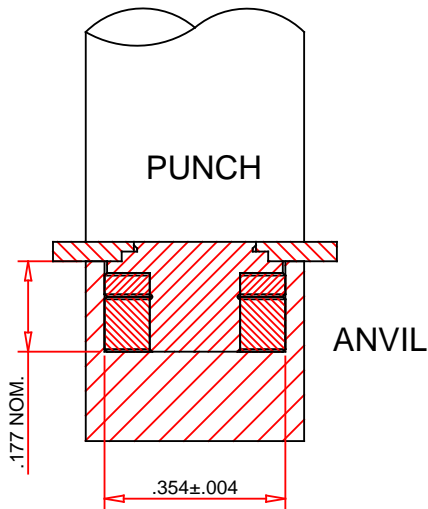

© 2024 PennEngineering

ALL DIMENSIONS IN INCHES

DATE 9-APR-2024

NOTE : DRAWING NOT TO SCALE

THREAD :	NONE	MOUNTING HOLE DIA. :	.240 +.003 -.000
MATERIAL:	SEE TABLE	PANEL THICKNESS:	.040 MINIMUM
HEAT TREAT:	SEE TABLE	MAX. PANEL HARDNESS:	HRB 80 / HB 150
FINISH:	SEE TABLE	MIN CENTERLINE-TO-EDGE:	0.29

DESCRIPTION :
Self-Clinching Roller Bearing Fasteners - PFTRCS



PennEngineering®

PART NO. :
PFTRCS-9.0-1.0

EMAIL: TECHSUPPORT@PEMNET.COM
WWW.PEMNET.COM